

Analog Devices Welcomes Hittite Microwave Corporation

NO CONTENT ON THE ATTACHED DOCUMENT HAS CHANGED



THIS PAGE INTENTIONALLY LEFT BLANK



Typical Applications

The HMC758LP3(E) is ideal for:

- Cellular Infrastructure, WiMAX & LTE/4G
- Software Defined Radios
- Repeaters and Femtocells
- Access Points
- Test & Measurement Equipment

Features

- Noise Figure: 1.7 dB
- Gain: 22 dB
- Output IP3: +37 dBm
- Single Supply: +3V to +5V
- 50 Ohm Matched Input/Output
- 16 Lead 3x3 mm SMT Package: 9 mm²

Functional Diagram

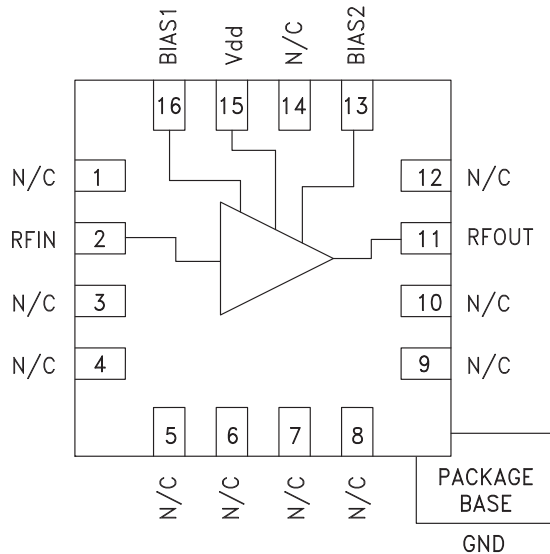

General Description

The HMC758LP3(E) is a GaAs pHEMT MMIC Low Noise Amplifier that is ideal for Cellular Infrastructure, WiMAX & LTE/4G basestation front-end receivers operating between 700 and 2200 MHz. The amplifier has been optimized to provide 1.7 dB noise figure, 21 dB gain and +37 dBm output IP3 from a single supply of +5V. Input and output return losses are excellent with minimal external matching and bias decoupling components. The HMC758LP3(E) can be biased with +3V to +5V and features an externally adjustable supply current, which allows the designer to tailor the linearity performance of the LNA for each application.

Electrical Specifications, $T_A = +25^\circ C$, $R1 = 390\Omega$, $R2 = 560\Omega^*$

Parameter	Vdd = +3V						Vdd = +5V						Units
	Min.	Typ.	Max.	Min.	Typ.	Max.	Min.	Typ.	Max.	Min.	Typ.	Max.	
Frequency Range	700 - 1700			1700 - 2200			700 - 1700			1700 - 2200			MHz
Gain	19	21.8		16	19.4		20	22.7		18	21.3		dB
Gain Variation Over Temperature		0.005			0.01			0.004			0.01		dB/°C
Noise Figure		1.6	2.5		1.4	1.8		1.7	2.6		1.6	2.0	dB
Input Return Loss		15			13			14			14		dB
Output Return Loss		11			15			10			12		dB
Output Power for 1 dB Compression (P1dB)	16	18		18	20		20.5	22.5		22	24		dBm
Saturated Output Power (Psat)		20			21.5			23.5			25		dBm
Output Third Order Intercept (IP3)		31			31.5			36			35		dBm
Supply Current (Idd)	80	102	130	80	102	130	190	227	260	190	227	260	mA

* R1 & R2 resistors set current, see application circuit herein



HMC758LP3 / 758LP3E

GaAs SMT pHEMT LOW NOISE AMPLIFIER, 700 - 2200 MHz

Broadband Gain & Return Loss

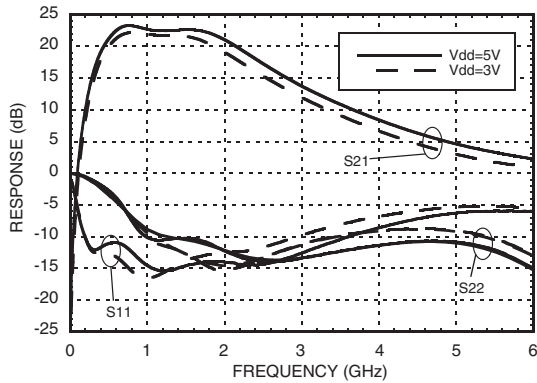

Gain vs. Temperature, V_{dd} = +5V

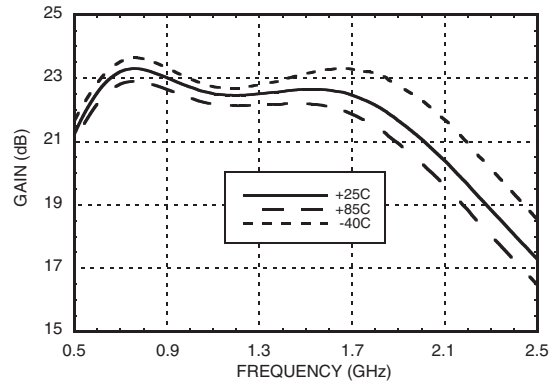

Gain vs. Temperature, V_{dd} = +3V

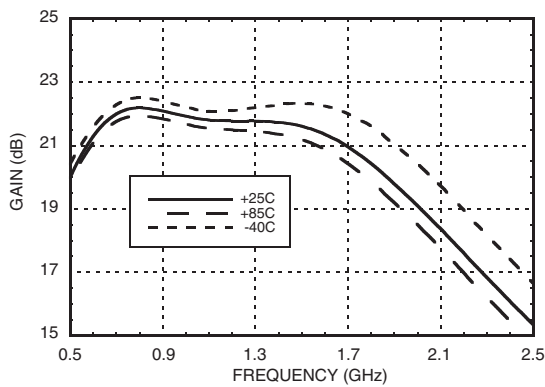

Input Return Loss vs. Temperature, V_{dd} = +5V

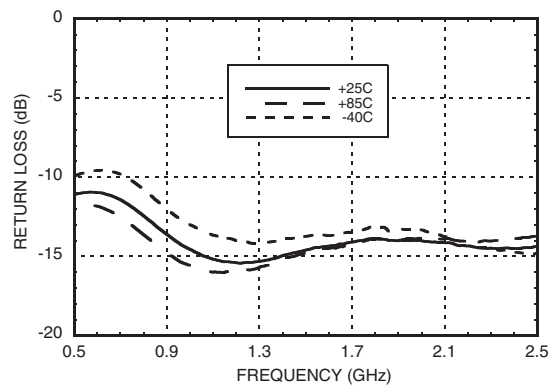

Output Return Loss vs. Temperature, V_{dd} = +5V

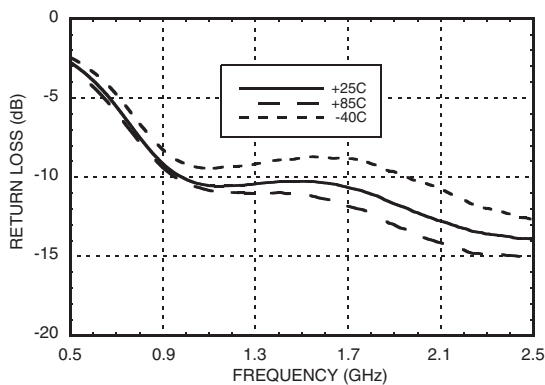

Reverse Isolation vs. Temperature, V_{dd} = +5V

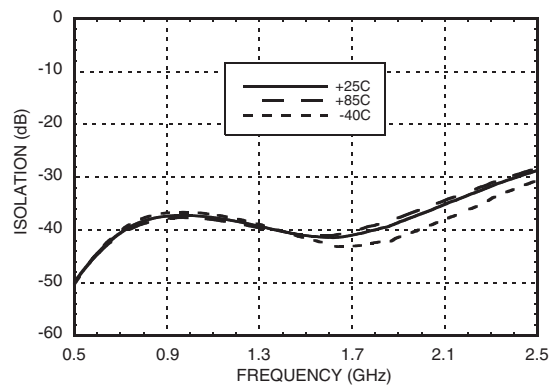

Noise Figure vs. Temperature [1]

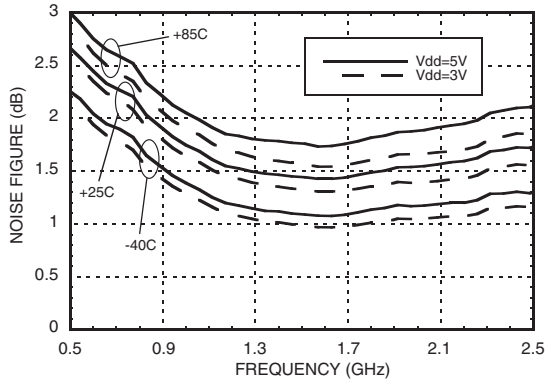

Output IP3 vs. Temperature

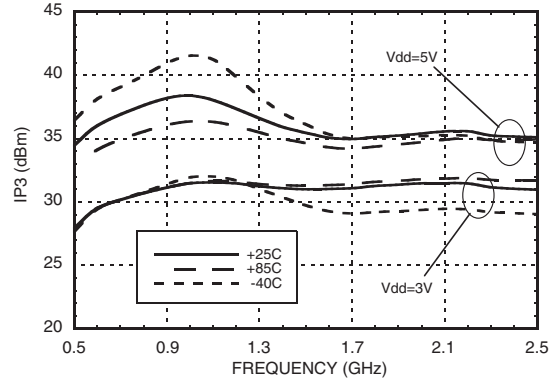

Output IP3 and Supply Current vs. Supply Voltage @ 900 MHz

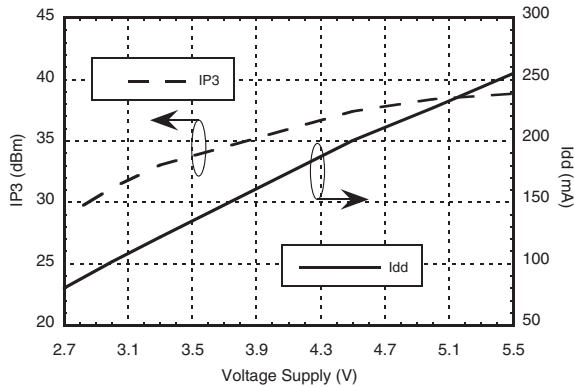

Output IP3 and Supply Current vs. Supply Voltage @ 1900 MHz

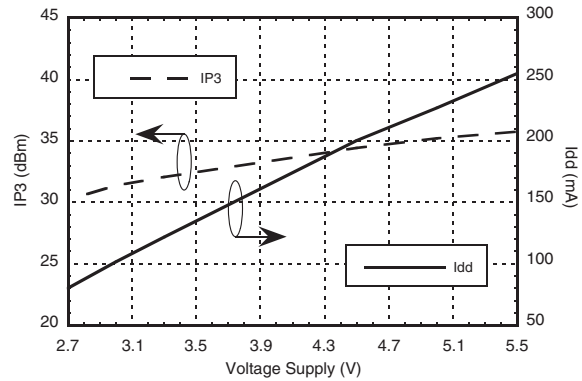

Output IP3 vs. Output Power @ 900 MHz

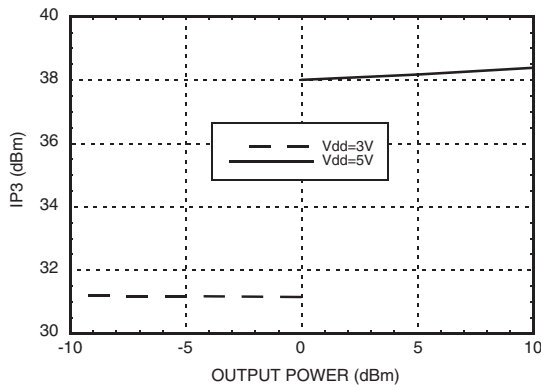

Output IP3 vs. Output Power @ 1900 MHz

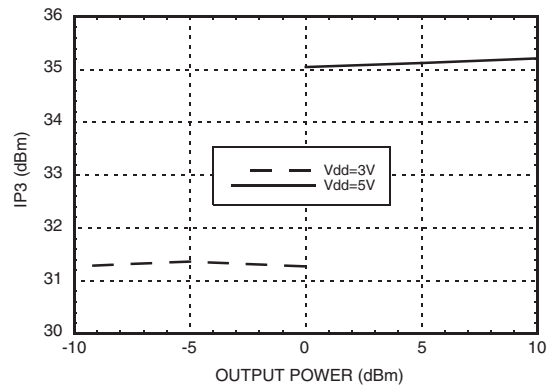

[1] Measurement reference plane shown on evaluation PCB drawing.



Power Compression @ 900 MHz [1]

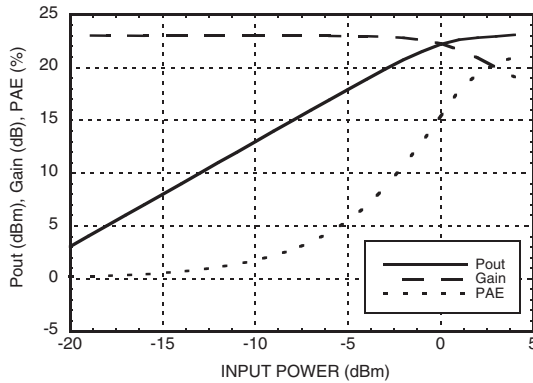

Power Compression @ 900 MHz [2]

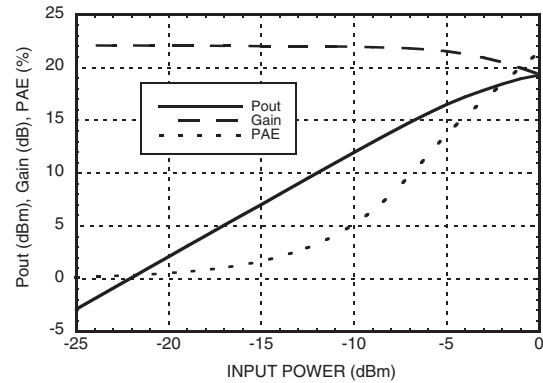

Power Compression @ 1900 MHz [1]

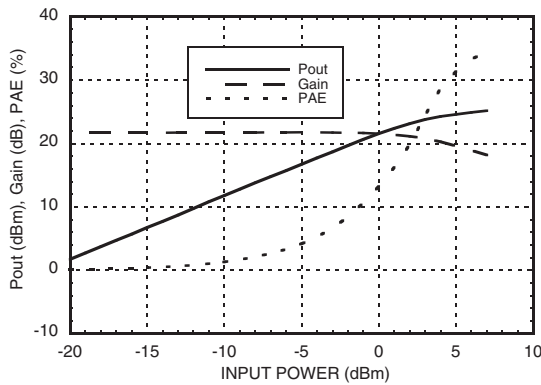

Power Compression @ 1900 MHz [2]

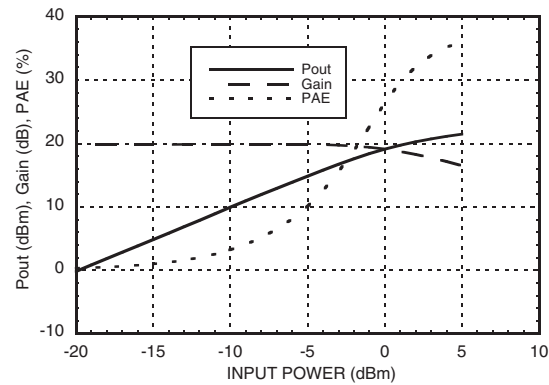

Recommended Bias Resistor Values for Idd

Vdd (V)	R1 (Ohms)	R2 (Ohms)	Idd (mA)
3V	390	560	102
3V	1k	1.5k	85
3V	3.3k	4.7k	54
5V	390	560	227
5V	1k	1.5k	190
5V	3.3k	4.7k	124

Typical Supply Current vs. Vdd (R1 = 390Ω, R2 = 560Ω)

Vdd (V)	Idd (mA)
2.7	80
3	102
3.3	122
4.5	200
5	227
5.5	255

Note: Amplifier will operate over full voltage range shown above.

Absolute Min/Max Bias Resistor Range

Max		Min	
R1 (Ohms)	R2 (Ohms)	R1 (Ohms)	R2 (Ohms)
3.9k	5.6k	270	470

[1] Vdd = 5V [2] Vdd = 3V

Absolute Maximum Ratings

Drain Bias Voltage (Vdd)	+6 V
RF Input Power (RFIN) (Vdd = +5V)	+5 dBm
Channel Temperature	150 °C
Continuous Pdiss (T= 85 °C) (derate 20 mW/°C above 85 °C)	1.3 W
Thermal Resistance (channel to ground paddle)	50 °C/W
Storage Temperature	-65 to +150 °C
Operating Temperature	-40 to +85 °C



ELECTROSTATIC SENSITIVE DEVICE
OBSERVE HANDLING PRECAUTIONS

Outline Drawing

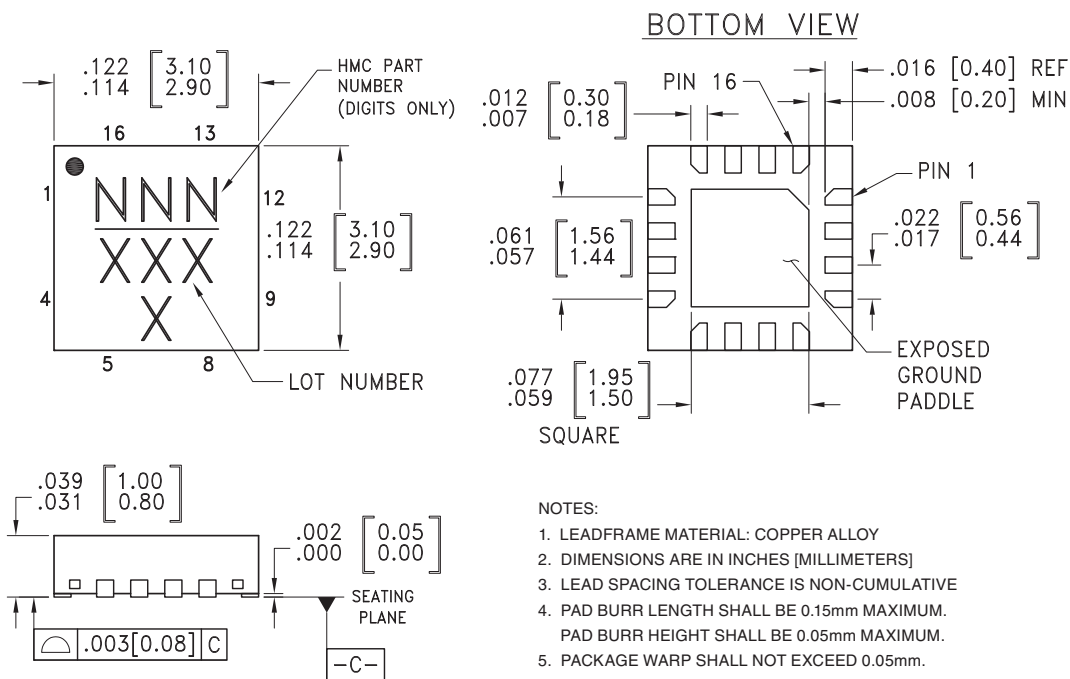

NOTES:

- LEADFRAME MATERIAL: COPPER ALLOY
- DIMENSIONS ARE IN INCHES [MILLIMETERS]
- LEAD SPACING TOLERANCE IS NON-CUMULATIVE
- PAD BURR LENGTH SHALL BE 0.15mm MAXIMUM.
PAD BURR HEIGHT SHALL BE 0.05mm MAXIMUM.
- PACKAGE WARP SHALL NOT EXCEED 0.05mm.
- ALL GROUND LEADS AND GROUND PADDLE MUST BE SOLDERED TO PCB RF GROUND.
- REFER TO HITTITE APPLICATION NOTE FOR SUGGESTED LAND PATTERN.

Package Information

Part Number	Package Body Material	Lead Finish	MSL Rating	Package Marking ^[3]
HMC758LP3	Low Stress Injection Molded Plastic	Sn/Pb Solder	MSL1 ^[1]	758 XXXX
HMC758LP3E	RoHS-compliant Low Stress Injection Molded Plastic	100% matte Sn	MSL1 ^[2]	758 XXXX

[1] Max peak reflow temperature of 235 °C
 [2] Max peak reflow temperature of 260 °C
 [3] 4-Digit lot number XXXX

Pin Descriptions

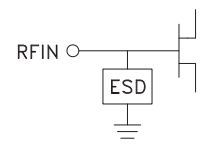
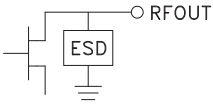
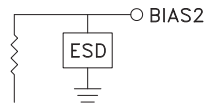
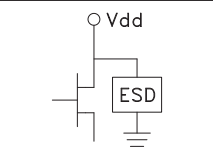
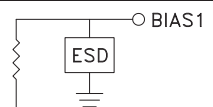
Pin Number	Function	Description	Interface Schematic
1, 3 - 6, 7 - 10, 12, 14	N/C	No connection required. These pins may be connected to RF/DC ground without affecting performance.	
2	RFIN	This pin is DC coupled. An off-chip DC blocking capacitor is required.	
11	RFOUT	This pin is DC coupled. An off-chip DC blocking capacitor is required.	
13	BIAS2	This pin is used to set the DC current of the second stage amplifier by selection of external bias resistor. See application circuit.	
15	Vdd	Power Supply Voltage for the amplifier. Bypass capacitors are required. See application circuit.	
16	BIAS1	This pin is used to set the DC current of the first stage amplifier by selection of external bias resistor. See application circuit.	



Application Circuit

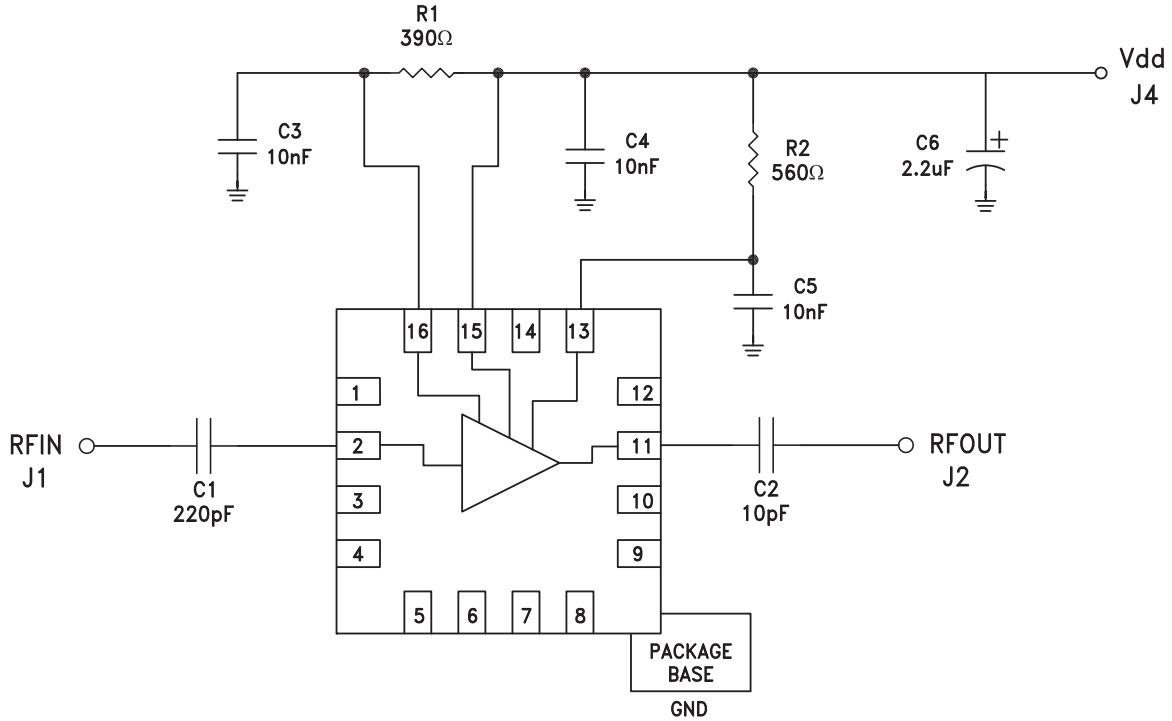

Evaluation PCB

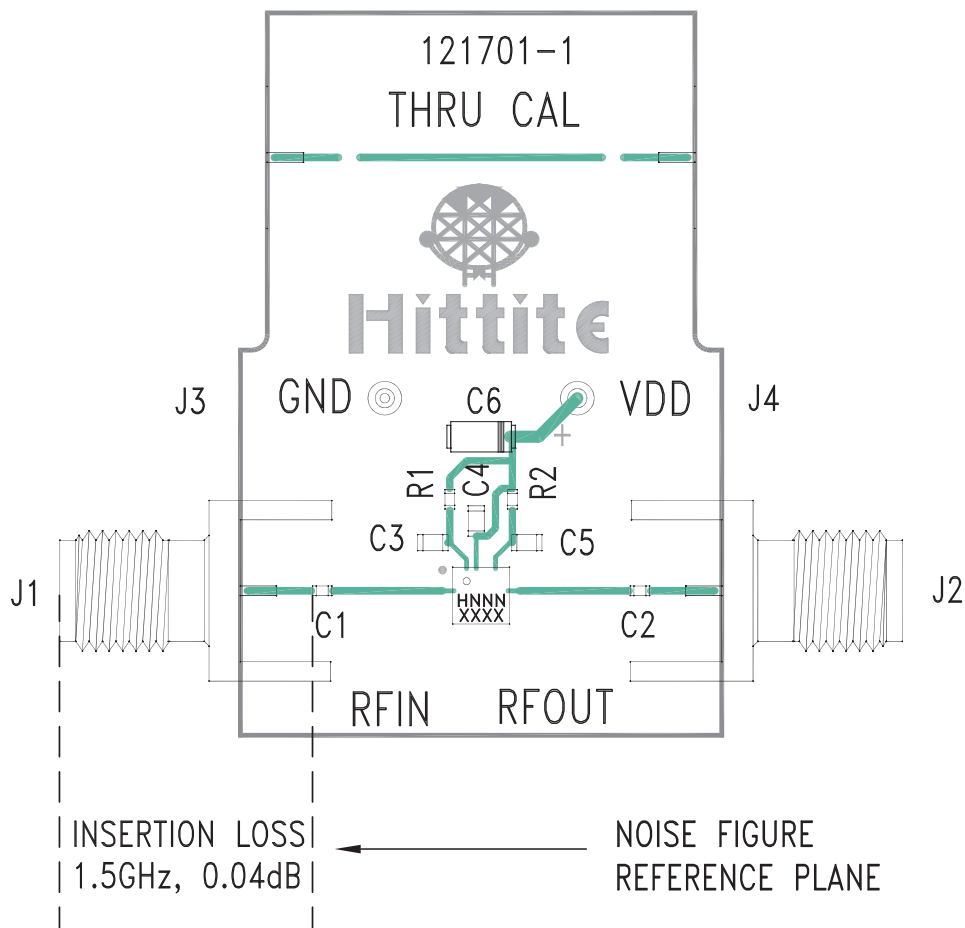

List of Materials for Evaluation PCB 121703 [1]

Item	Description
J1, J2	PCB Mount SMA RF Connector
J3, J4	DC Pin
C1	220 pF Capacitor, 0402 Pkg.
C2	10 pF Capacitor, 0402 Pkg.
C3 - C5	10 nF Capacitor, 0603 Pkg.
C6	2.2 μ F Tantalum Capacitor
R1	390 Ohm Resistor, 0402 Pkg.
R2	560 Ohm Resistor, 0402 Pkg.
U1	HMC758LP3(E) Amplifier
PCB [2]	121701 Evaluation PCB

The circuit board used in this application should use RF circuit design techniques. Signal lines should have 50 Ohm impedance while the package ground leads and exposed paddle should be connected directly to the ground plane similar to that shown. A sufficient number of via holes should be used to connect the top and bottom ground planes. The evaluation board should be mounted to an appropriate heat sink. The evaluation circuit board shown is available from Hittite upon request.

[1] Reference this number when ordering complete evaluation PCB

[2] Circuit Board Material: Rogers 4350 or Arlon 25FR.